

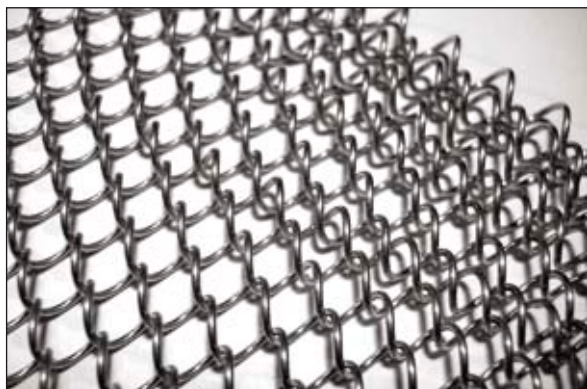

TWENTINOX

ARCHITECTURAL WOVEN FABRIC

ARCHITECTURAL WOVEN FABRICS



SIERRA PAPA small



SIERRA PAPA large

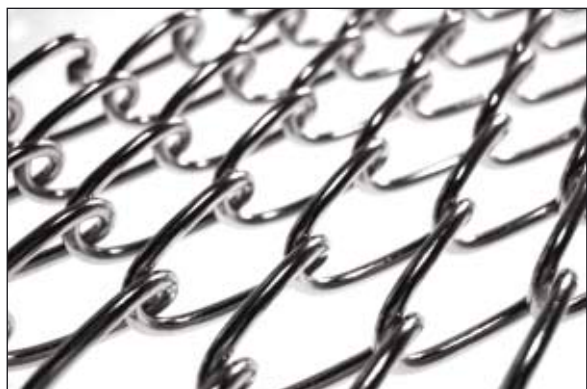

HOTEL ALFA middle



SIERRA PAPA 2

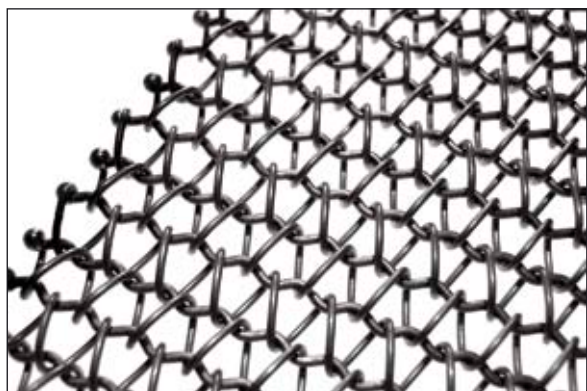

GOLF SIERRA small

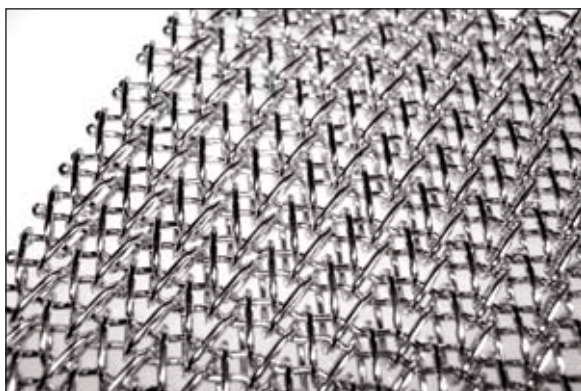

CHARLIE BRAVO

WWW.TWENTINOX.COM

TWENTINOX IS A TWENTEBELT BV COMPANY

▶ TWENTINOX ▶ P.O. BOX 6 ▶ 7550 AA ▶ HENGELO OY ▶ THE NETHERLANDS ▶
▶ PETROLEUMHAVENSTRAAT 1-3 ▶ 7553 GS ▶ HENGELO OY ▶
▶ TEL +31 (0)74 291 69 96 ▶ FAX +31 (0)74 243 16 59 ▶

▶ E-MAIL INFO@TWENTINOX.COM ▶ WWW.TWENTINOX.COM ▶
▶ ABN-AMRO BANK 59 02 48 200 ▶ SWIFTCODE ABNANL2A ▶ IBAN NL15ABNA 0590248200 ▶
▶ POSTBANK 858804 ▶ V.A.T. NO. NL0012 63 663 801 ▶ K.V.K. ENSCHEDE NO. 06010145 ▶



TWENTINOX

ARCHITECTURAL WOVEN FABRIC

ARCHITECTURAL WOVEN FABRICS



GOLF SIERRA (flat wire)

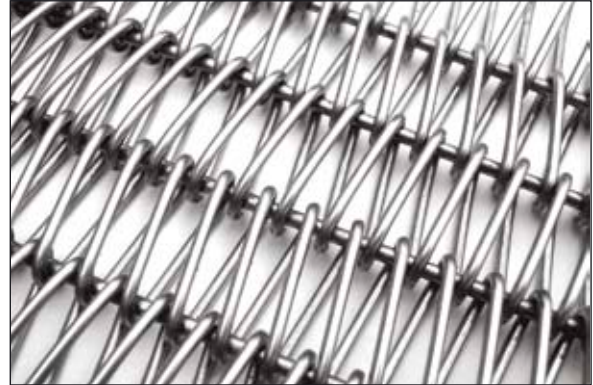

ROMEO SIERRA



GOLF ROMEO small



GOLF ROMEO large



DELTA LIMA

MATERIAL: Stainless steel (steel, aluminium, others on request).

CHARACTERISTICS: Strong, durable and flexible material, translucent with dynamic perspective, low maintenance.

FINISH: Matt, gloss, colour-shine.

USE: Facades, curtains, room dividers, ceilings, rolling doors, media frames..

WWW.TWENTINOX.COM

TWENTINOX IS A TWENTEBELT BV COMPANY

▶ TWENTINOX ▶ P.O. BOX 6 ▶ 7550 AA HENGELO OY ▶ THE NETHERLANDS ▶
▶ PETROLEUMHAVENSTRAAT 1-3 ▶ 7553 GS HENGELO OY ▶
▶ TEL +31 (0)74 291 69 96 ▶ FAX +31 (0)74 243 16 59 ▶

▶ E-MAIL INFO@TWENTINOX.COM ▶ WWW.TWENTINOX.COM ▶
▶ ABN-AMRO BANK 59 02 48 200 ▶ SWIFTCODE ABNANL2A ▶ IBAN NL15ABNA 0590248200 ▶
▶ POSTBANK 858804 ▶ V.A.T. NO. NL0012 63 663 801 ▶ K.V.K. ENSCHEDE NO. 06010145 ▶



TWENTINOX

ARCHITECTURAL WOVEN FABRIC

CHARLIE BRAVO

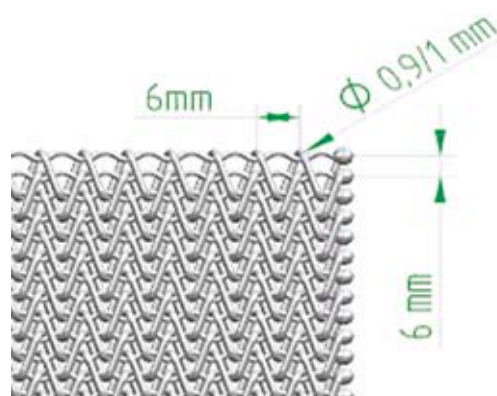
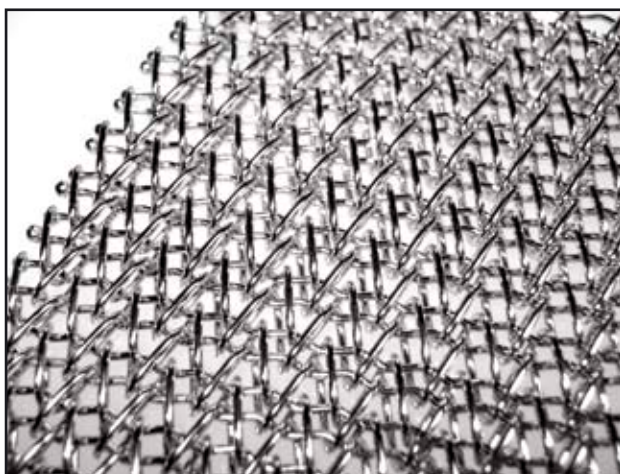

Product information:	
Description:	CHARLIE BRAVO is a specific metal mesh with small openings. Characterized by oval spirals with multiple waved cross rods.
Material:	Glossy stainless steel
Applications:	Wall and ceiling panels, façade, furniture, jewellery, creative modern furniture
Weight:	7,2 kg/ m ²
Size:	↔ 6 mm; ↑ 6 mm; Ø 0,9/1 mm

Options:	
Materials:	Stainless steel, bronze, copper, aluminium, silver, gold
Finish:	Matt, glossy, coloured
Dimensions:	width: up to 6000 mm (20')

WWW.TWENTINOX.COM

TWENTINOX IS A TWENTEBELT BV COMPANY

▶ TWENTINOX ▶ P.O. BOX 6 ▶ 7550 AA ▶ HENGELO OY ▶ THE NETHERLANDS ▶
▶ PETROLEUMHAVENSTRAAT 1-3 ▶ 7553 GS ▶ HENGELO OY ▶
▶ TEL +31 (0)74 291 69 96 ▶ FAX +31 (0)74 243 16 59 ▶

▶ E-MAIL INFO@TWENTINOX.COM ▶ WWW.TWENTINOX.COM ▶
▶ ABN-AMRO BANK 59 02 48 200 ▶ SWIFTCODE ABNANL2A ▶ IBAN NL15ABNA 0590248200 ▶
▶ POSTBANK 858804 ▶ V.A.T. NO. NL0012 63 663 801 ▶ K.V.K. ENSCHEDE NO. 06010145 ▶



TWENTINOX

ARCHITECTURAL WOVEN FABRIC

DELTA LIMA large

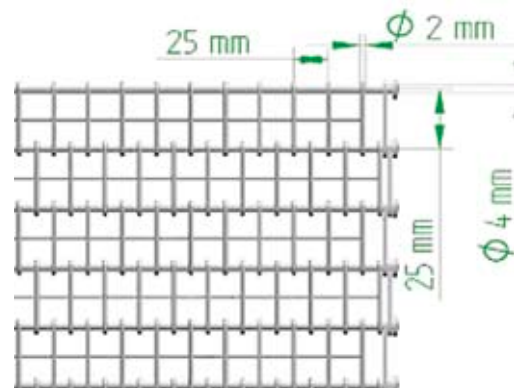

Product information:	
Description:	DELTA LIMA is a very strong metal mesh. Characterized by straight pins, big openings and a welded side.
Material:	Stainless steel
Applications:	roller door, security system
Weight:	6 kg/ m ²
Size:	↔ 25 mm; ↓ 25 mm; Ø 2/4 mm

Options:	
Materials:	Stainless steel
Finish:	matt, glossy, coloured
Dimensions:	width: up to 6000 mm (20')

WWW.TWENTINOX.COM

TWENTINOX IS A TWENTEBELT BV COMPANY

▶ TWENTINOX ▶ P.O. BOX 6 ▶ 7550 AA ▶ HENGELO OY ▶ THE NETHERLANDS ▶
▶ PETROLEUMHAVENSTRAAT 1-3 ▶ 7553 GS ▶ HENGELO OY ▶
▶ TEL +31 (0)74 291 69 96 ▶ FAX +31 (0)74 243 16 59 ▶

▶ E-MAIL INFO@TWENTINOX.COM ▶ WWW.TWENTINOX.COM ▶
▶ ABN-AMRO BANK 59 02 48 200 ▶ SWIFTCODE ABNANL2A ▶ IBAN NL15ABNA 0590248200 ▶
▶ POSTBANK 858804 ▶ V.A.T. NO. NL0012 63 663 801 ▶ K.V.K. ENSCHEDE NO. 06010145 ▶



TWENTINOX

ARCHITECTURAL WOVEN FABRIC

GOLF ROMEO large

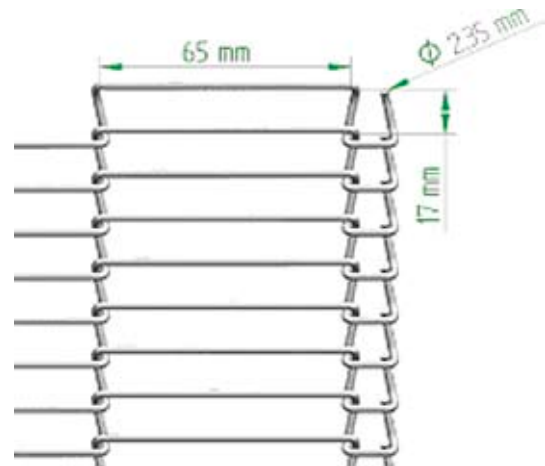

Product information:	
Description:	GOLF ROMEO large has big openings, characterized by long lasting and low maintenance.
Material:	Stainless steel
Applications:	Media frame, metal façade covering
Weight:	3,5 kg/ m ²
Size:	↔ 65 mm; ↓ 17 mm; Ø 2,35 mm

Options:	
Materials:	Stainless steel
Finish:	matt, glossy, coloured
Dimensions:	width: up to 6000 mm (20')

WWW.TWENTINOX.COM

TWENTINOX IS A TWENTEBELT BV COMPANY

▶ TWENTINOX ▶ P.O. BOX 6 ▶ 7550 AA ▶ HENGELO OV ▶ THE NETHERLANDS ▶
▶ PETROLEUMHAVENSTRAAT 1-3 ▶ 7553 GS ▶ HENGELO OV ▶
▶ TEL +31 (0)74 291 69 96 ▶ FAX +31 (0)74 243 16 59 ▶

▶ E-MAIL INFO@TWENTINOX.COM ▶ WWW.TWENTINOX.COM ▶
▶ ABN-AMRO BANK 59 02 48 200 ▶ SWIFTCODE ABNANL2A ▶ IBAN NL15ABNA 0590248200 ▶
▶ POSTBANK 858804 ▶ V.A.T. NO. NL0012 63 663 801 ▶ K.V.K. ENSCHEDE NO. 06010145 ▶



TWENTINOX

ARCHITECTURAL WOVEN FABRIC

GOLF ROMEO small

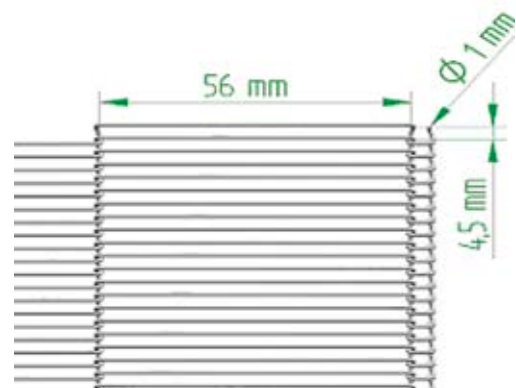
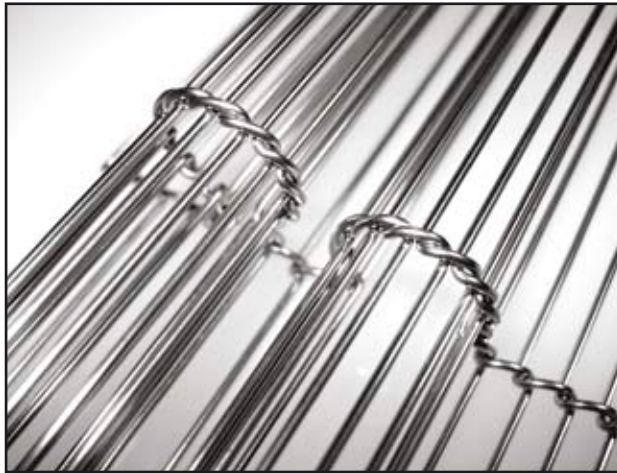

Product information:	
Description:	The architectural mesh has small openings, provides a characteristic style and aesthetic design. The mesh is made from a flat thin woven wire.
Material:	Stainless steel
Applications:	Interior decoration, façade covering, curtains, ceilings
Weight:	1,7 kg/ m ²
Size:	↔ 56 mm; ↓ 4,5 mm; Ø 1 mm

Options:	
Materials:	Stainless steel
Versions:	trapezium shaped mesh
Finish:	matt, glossy, coloured
Dimensions:	width: up to 6000 mm (20')

WWW.TWENTINOX.COM

TWENTINOX IS A TWENTEBELT BV COMPANY

▶ TWENTINOX ▶ P.O. BOX 6 ▶ 7550 AA ▶ HENGELO OY ▶ THE NETHERLANDS ▶
▶ PETROLEUMHAVENSTRAAT 1-3 ▶ 7553 GS ▶ HENGELO OY ▶
▶ TEL +31 (0)74 291 69 96 ▶ FAX +31 (0)74 243 16 59 ▶

▶ E-MAIL INFO@TWENTINOX.COM ▶ WWW.TWENTINOX.COM ▶
▶ ABN-AMRO BANK 59 02 48 200 ▶ SWIFTCODE ABNANL2A ▶ IBAN NL15ABNA 0590248200 ▶
▶ POSTBANK 858804 ▶ V.A.T. NO. NL0012 63 663 801 ▶ K.V.K. ENSCHEDE NO. 06010145 ▶



ARCHITECTURAL WOVEN FABRIC

GOLF SIERRA small

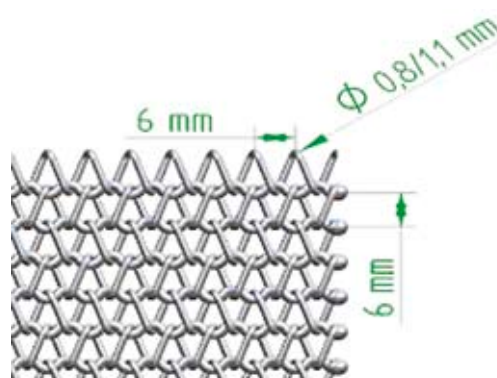
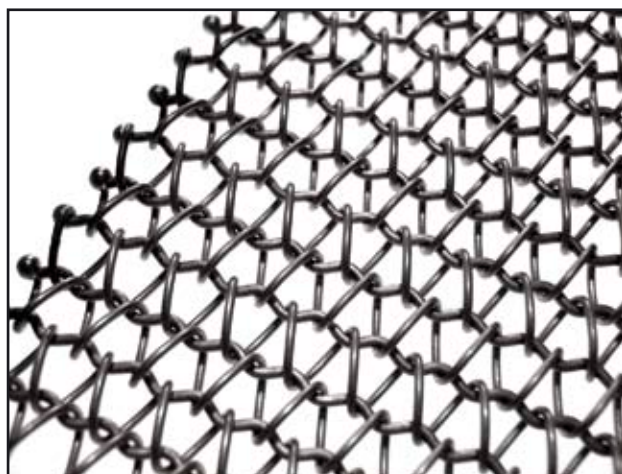

Product information:	
Description:	An architectural fabric with small openings, woven on corrugated pins, welded on edges.
Material:	Matt stainless steel
Applications:	ceiling panels, wall coverings, elevator panels, metal sunscreens
Weight:	4,2 kg/ m ²
Size:	↔ 6 mm; ↓ 6 mm; Ø 0,8/1,1 mm

Options:	
Materials:	Stainless steel, bronze, copper, aluminum, silver, gold
Finish:	matt, glossy, coloured
Dimensions:	width: up to 6000 mm (20')

WWW.TWENTINOX.COM

TWENTINOX IS A TWENTEBELT BV COMPANY

▶ TWENTINOX ▶ P.O. BOX 6 ▶ 7550 AA ▶ HENGELO OY ▶ THE NETHERLANDS ▶
 ▶ PETROLEUMHAVENSTRAAT 1-3 ▶ 7553 GS ▶ HENGELO OY ▶
 ▶ TEL +31 (0)74 291 69 96 ▶ FAX +31 (0)74 243 16 59 ▶

▶ E-MAIL INFO@TWENTINOX.COM ▶ WWW.TWENTINOX.COM ▶
 ▶ ABN-AMRO BANK 59 02 48 200 ▶ SWIFTCODE ABNANL2A ▶ IBAN NL15ABNA 0590248200 ▶
 ▶ POSTBANK 858804 ▶ V.A.T. NO. NL0012 63 663 801 ▶ K.V.K. ENSCHEDE NO. 06010145 ▶



TWENTINOX

ARCHITECTURAL WOVEN FABRIC

GOLF SIERRA (flat wire)

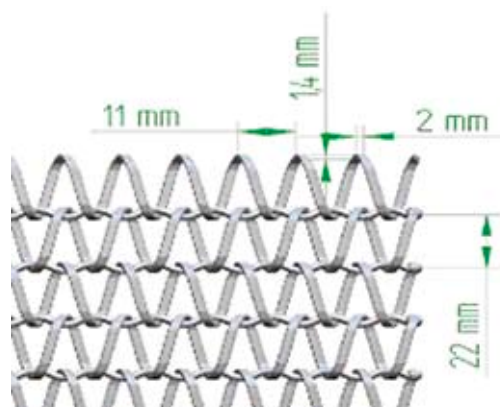

Product information:	
Description:	Flat spiral wire with a triangular shape of openings, and corrugated rods
Material:	Gloss stainless steel
Applications:	ceiling panels, wall coverings, metal curtains, façade, room divider, façade elevator elements
Weight:	9 kg/ m ²
Size:	↔ 11 mm; ↓ 22 mm; Ø 1,4/2 mm

Options:	
Materials:	Stainless steel, bronze, copper, aluminum, silver, gold
Finish:	matt, glossy, coloured
Dimensions:	width: up to 6000 mm (20')

WWW.TWENTINOX.COM

TWENTINOX IS A TWENTEBELT BV COMPANY

▶ TWENTINOX ▶ P.O. BOX 6 ▶ 7550 AA ▶ HENGELO OY ▶ THE NETHERLANDS ▶
▶ PETROLEUMHAVENSTRAAT 1-3 ▶ 7553 GS ▶ HENGELO OY ▶
▶ TEL +31 (0)74 291 69 96 ▶ FAX +31 (0)74 243 16 59 ▶

▶ E-MAIL INFO@TWENTINOX.COM ▶ WWW.TWENTINOX.COM ▶
▶ ABN-AMRO BANK 59 02 48 200 ▶ SWIFTCODE ABNANL2A ▶ IBAN NL15ABNA 0590248200 ▶
▶ POSTBANK 858804 ▶ V.A.T. NO. NL0012 63 663 801 ▶ K.V.K. ENSCHEDE NO. 06010145 ▶



TWENTINOX

ARCHITECTURAL WOVEN FABRIC

HOTEL ALFA middle

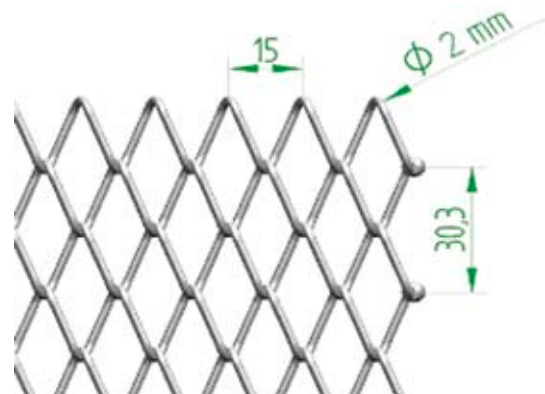
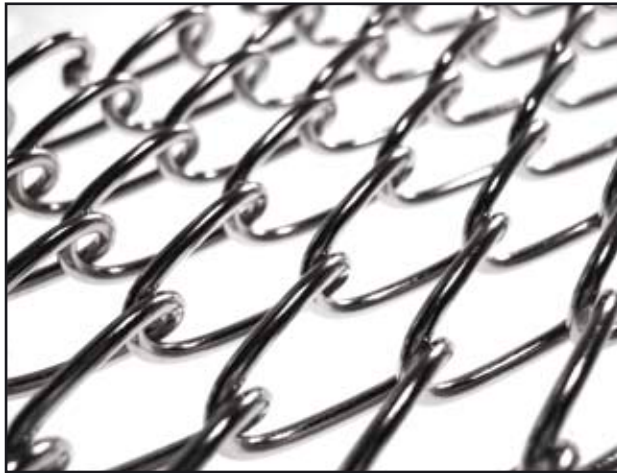

Product information:	
Description:	Metal mesh with woven spirals wire. The flexible fabric with big openings and welded edges
Material:	Stainless steel
Applications:	room divider, metal curtain
Weight:	6 kg/ m ²
Size:	↔ 13 mm; ↑ 30 mm; Ø 2 mm

Options:	
Materials:	Stainless steel, bronze, copper, aluminium, silver, gold
Finish:	matt, glossy, coloured
Dimensions:	width: up to 6000 mm (20')

WWW.TWENTINOX.COM

TWENTINOX IS A TWENTEBELT BV COMPANY

▶ TWENTINOX ▶ P.O. BOX 6 ▶ 7550 AA ▶ HENGELO OY ▶ THE NETHERLANDS ▶
▶ PETROLEUMHAVENSTRAAT 1-3 ▶ 7553 GS ▶ HENGELO OY ▶
▶ TEL +31 (0)74 291 69 96 ▶ FAX +31 (0)74 243 16 59 ▶

▶ E-MAIL INFO@TWENTINOX.COM ▶ WWW.TWENTINOX.COM ▶
▶ ABN-AMRO BANK 59 02 48 200 ▶ SWIFTCODE ABNANL2A ▶ IBAN NL15ABNA 0590248200 ▶
▶ POSTBANK 858804 ▶ V.A.T. NO. NL0012 63 663 801 ▶ K.V.K. ENSCHEDE NO. 06010145 ▶



ARCHITECTURAL WOVEN FABRIC

ROMEO SIERRA small

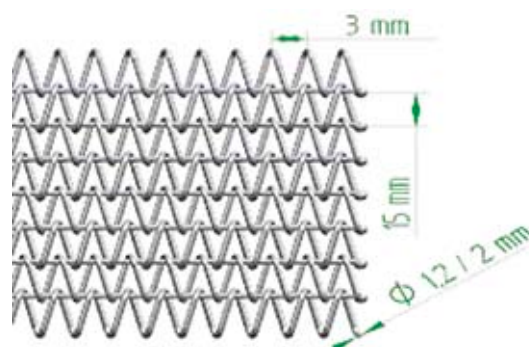

Product information:	
Description:	Architectural meshes characterized by a round spiral wire with looped edges.
Material:	Matt stainless steel
Applications:	Wall covering, ceiling panels, façade covering, railings
Weight:	11,5 kg/ m ²
Size:	↔ 3 mm; ↓ 15 mm; Ø 1,2/2 mm

Options:	
Materials:	Stainless steel, bronze, copper, aluminium, silver, gold
Finish:	matt, glossy, coloured
Dimensions:	width: up to 6000 mm (20')

WWW.TWENTINOX.COM

TWENTINOX IS A TWENTEBELT BV COMPANY

▶ TWENTINOX ▶ P.O. BOX 6 ▶ 7550 AA ▶ HENGELO OY ▶ THE NETHERLANDS ▶
 ▶ PETROLEUMHAVENSTRAAT 1-3 ▶ 7553 GS ▶ HENGELO OY ▶
 ▶ TEL +31 (0)74 291 69 96 ▶ FAX +31 (0)74 243 16 59 ▶

▶ E-MAIL INFO@TWENTINOX.COM ▶ WWW.TWENTINOX.COM ▶
 ▶ ABN-AMRO BANK 59 02 48 200 ▶ SWIFTCODE ABNANL2A ▶ IBAN NL15ABNA 0590248200 ▶
 ▶ POSTBANK 858804 ▶ V.A.T. NO. NL0012 63 663 801 ▶ K.V.K. ENSCHEDE NO. 06010145 ▶



TWENTINOX

ARCHITECTURAL WOVEN FABRIC

SIERRA PAPA large

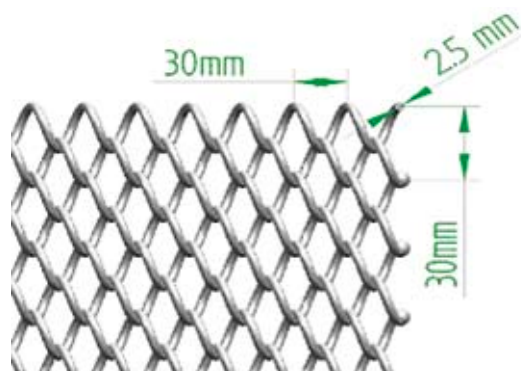

Product information:	
Description:	SIERRA PAPA large is characterized by a round glossy woven thick spiral wire. The mesh is flexible in one direction and has big openings.
Material:	Gloss stainless steel
Applications:	Room dividers, metal curtains, balustrade
Weight:	5,2 kg/ m ²
Size:	↔ 30 mm; ↓ 30 mm; Ø 2,5 mm

Options:	
Materials:	Stainless steel, bronze, copper, aluminium, silver, gold
Finish:	matt, glossy, coloured
Dimensions:	width: up to 6000 mm (20')

WWW.TWENTINOX.COM

TWENTINOX IS A TWENTEBELT BV COMPANY

▶ TWENTINOX ▶ P.O. BOX 6 ▶ 7550 AA ▶ HENGELO OY ▶ THE NETHERLANDS ▶
▶ PETROLEUMHAVENSTRAAT 1-3 ▶ 7553 GS ▶ HENGELO OY ▶
▶ TEL +31 (0)74 291 69 96 ▶ FAX +31 (0)74 243 16 59 ▶

▶ E-MAIL INFO@TWENTINOX.COM ▶ WWW.TWENTINOX.COM ▶
▶ ABN-AMRO BANK 59 02 48 200 ▶ SWIFTCODE ABNANL2A ▶ IBAN NL15ABNA 0590248200 ▶
▶ POSTBANK 858804 ▶ V.A.T. NO. NL0012 63 663 801 ▶ K.V.K. ENSCHEDE NO. 06010145 ▶



TWENTINOX

ARCHITECTURAL WOVEN FABRIC

SIERRA PAPA small

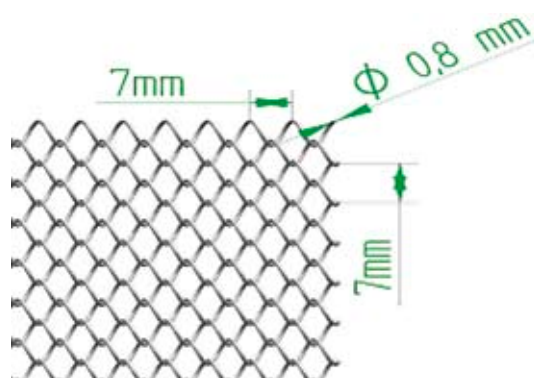
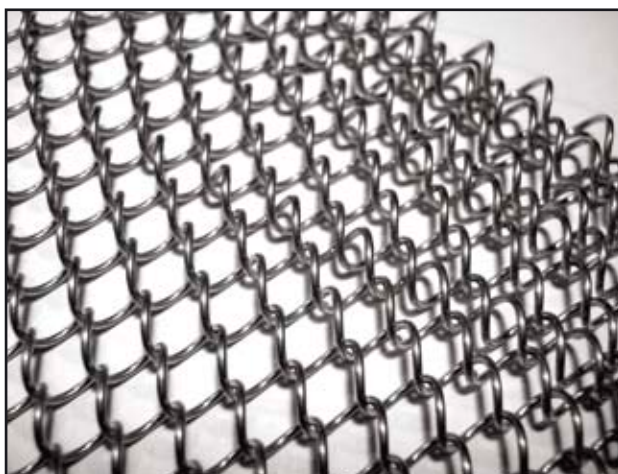

Product information:	
Description:	A light mesh with round woven spirals wire. A flexible fabric with small openings.
Material:	Stainless steel
Applications:	room divider, metal curtains, interior decoration
Weight:	2,5 kg/ m ²
Size:	↔ 7 mm; ↓ 7 mm; Ø 0,8 mm

Options:	
Materials:	Stainless steel, bronze, copper, aluminium, silver, gold
Finish:	matt, glossy, coloured
Dimensions:	width: up to 6000 mm (20')

WWW.TWENTINOX.COM

TWENTINOX IS A TWENTEBELT BV COMPANY

▶ TWENTINOX ▶ P.O. BOX 6 ▶ 7550 AA ▶ HENGLO OY ▶ THE NETHERLANDS ▶
▶ PETROLEUMHAVENSTRAAT 1-3 ▶ 7553 GS ▶ HENGLO OY ▶
▶ TEL +31 (0)74 291 69 96 ▶ FAX +31 (0)74 243 16 59 ▶

▶ E-MAIL INFO@TWENTINOX.COM ▶ WWW.TWENTINOX.COM ▶
▶ ABN-AMRO BANK 59 02 48 200 ▶ SWIFTCODE ABNANL2A ▶ IBAN NL15ABNA 0590248200 ▶
▶ POSTBANK 858804 ▶ V.A.T. NO. NL0012 63 663 801 ▶ K.V.K. ENSCHEDE NO. 06010145 ▶



TWENTINOX

ARCHITECTURAL WOVEN FABRIC

SIERRA PAPA 2

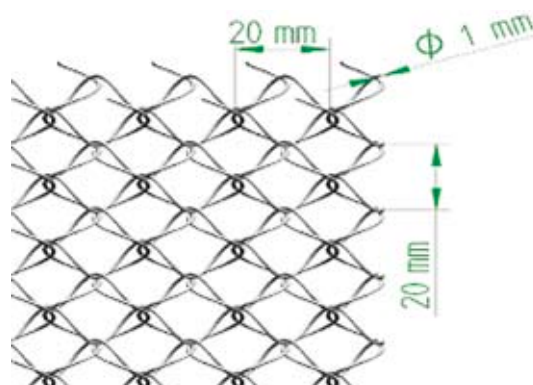

Product information:	
Description:	A lightweight rigid metal mesh with medium openings, with bi-woven spiral wire.
Material:	Gloss stainless steel
Applications:	Wall and ceiling panels, balustrade, railings
Weight:	3 kg/ m ²
Size:	↔ 20 mm; ↓ 20 mm; Ø 1,2 mm

Options:	
Materials:	Stainless steel, bronze, copper, aluminium, silver, gold
Finish:	matt, glossy, coloured
Dimensions:	width: up to 6000 mm (20')

WWW.TWENTINOX.COM

TWENTINOX IS A TWENTEBELT BV COMPANY

▶ TWENTINOX ▶ P.O. BOX 6 ▶ 7550 AA ▶ HENGELO OY ▶ THE NETHERLANDS ▶
▶ PETROLEUMHAVENSTRAAT 1-3 ▶ 7553 GS ▶ HENGELO OY ▶
▶ TEL +31 (0)74 291 69 96 ▶ FAX +31 (0)74 243 16 59 ▶

▶ E-MAIL INFO@TWENTINOX.COM ▶ WWW.TWENTINOX.COM ▶
▶ ABN-AMRO BANK 59 02 48 200 ▶ SWIFTCODE ABNANL2A ▶ IBAN NL15ABNA 0590248200 ▶
▶ POSTBANK 858804 ▶ V.A.T. NO. NL0012 63 663 801 ▶ K.V.K. ENSCHEDE NO. 06010145 ▶