

ARCHITECTURAL WOVEN FABRIC

METAL CURTAINS - ROOMDIVIDERS - SEPARATIONS



Metal curtains are perfect as room dividers and separations

Stylish and practical
Suitable for restaurants, hotels and exhibitions

Designers choose metal fabrics to create special effects with lighting

For its fireproof and hygienic qualities



GOLF ROMEO small in stainless steel



GOLF ROMEO small in a new copper alloy



Twentinox materials can be shaped into flat or dimensional panels for:

- facades
- ceilings
- separations
- blinds

Architects design with Twentinox materials for its durable and environment friendly maintenance qualities

Contact us for more info

WWW.TWENTINOX.COM

TWENTINOX IS A TWENTEBELT BV COMPANY

▶ TWENTINOX ▶ P.O. BOX 6 ▶ 7550 AA HENGEL O V ▶ THE NETHERLANDS ▶
▶ PETROLEUMHAVENSTRAAT 1-3 ▶ 7553 GS HENGEL O V ▶
▶ TEL +31 (0)74 291 69 96 ▶ FAX +31 (0)74 243 16 59 ▶

▶ E-MAIL INFO@TWENTINOX.COM ▶ WWW.TWENTINOX.COM ▶
▶ ABN-AMRO BANK 59 02 48 200 ▶ SWIFTCODE ABNANL2A ▶ IBAN NL15ABNA 0590248200 ▶
▶ POSTBANK 858804 ▶ V.A.T. NO. NL0012 63 663 B01 ▶ K.V.K. ENSCHEDE NO. 06010145 ▶

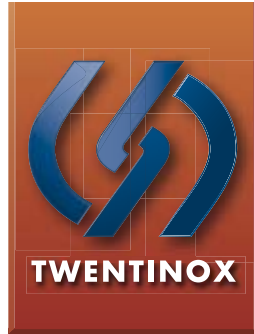

ARCHITECTURAL WOVEN FABRIC

TWENTINOX One-Rail



separation on single rail

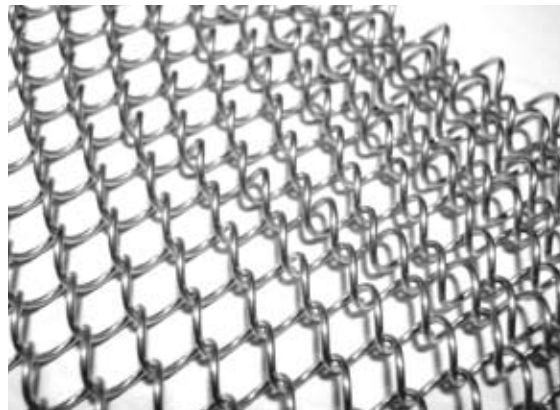

SIERRA PAPA small



dimensional view

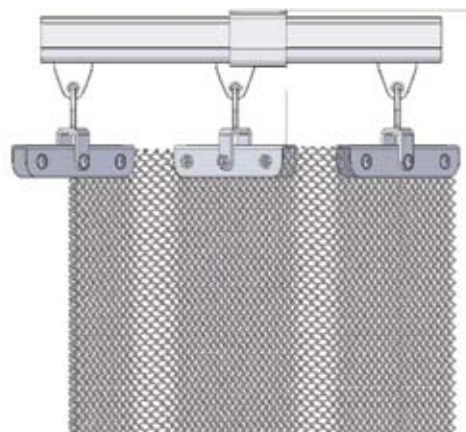

front view

TWENTINOX One-Rail with SIERRA PAPA small:

Material weight:	3,5 kg/m ²
Maximum height curtain:	↑ 3500 mm
Allowance for pleat:	width x 1,5 for sinus-pleat
Distance rail-support:	min. every 500 mm
Distance rail-spotlight:	min. ↔ 50 mm
Distance pleat side view:	↔ allow min. 150 mm for pleat
Distance rail-material:	↑ 100 mm between upper construction and material

Rail system: Helm&Woelm rail type 100 recommended
(rail and plastic rollers not included)

WWW.TWENTINOX.COM

TWENTINOX IS A TWENTEBELT BV COMPANY



One rail with SIERRA PAPA



One rail with GOLF ROMEO small

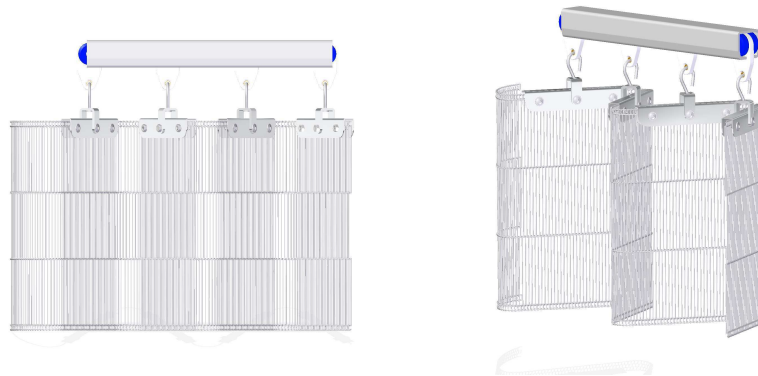

Two rail with GOLF ROMEO small

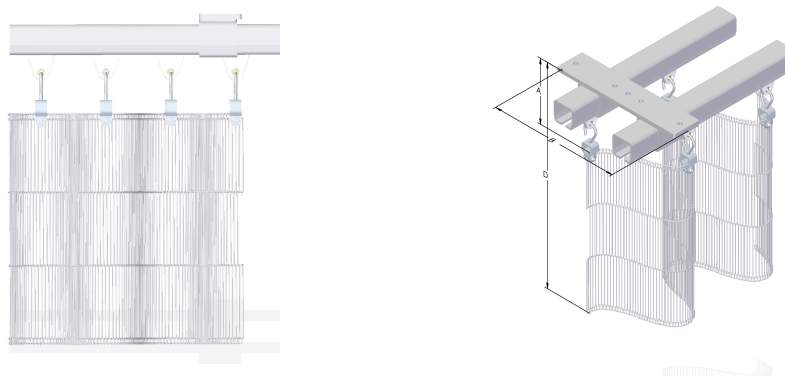

TWENTINOX IS A TWENTEBELT BV COMPANY

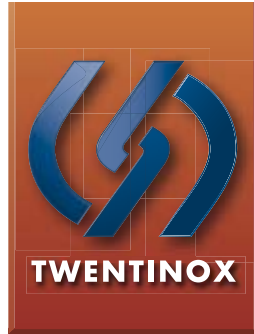

ARCHITECTURAL WOVEN FABRIC

TWENTINOX Two Rail



double rail with sinus shape



GOLF ROMEO small

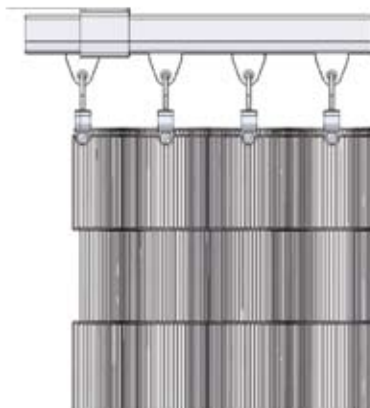

front view

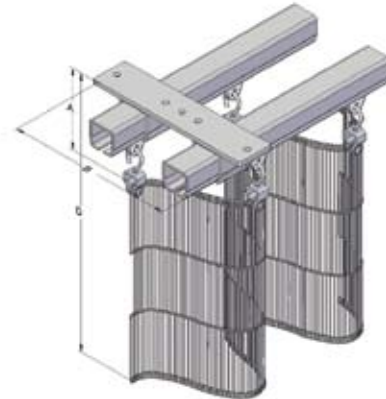

suspended rails (optional)

TWENTINOX Two-Rail with GOLF ROMEO small:

Material weight:	1,6 kg/m ²
Maximum height curtain:	↑ 4000 mm (D)
Allowance for pleat:	width x1,5 for sinus-pleat
Distance rail-support:	min. every 500 mm
Distance rail-spotlight:	min. ↔ 50 mm
Distance rail side view:	↔ allow min. 100 mm between rails (B)
Distance rail-material:	↑ 80 mm between upper construction and material (A)

Rail system: Helm&Woelm (type 45 or 100)
(rail and plastic rollers not included)

WWW.TWENTINOX.COM

TWENTINOX IS A TWENTEBELT BV COMPANY

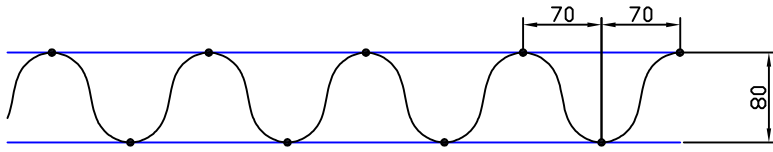

C-C Rail = 80mm
 Hanger elke 70mm
 Gordijnlengte tussen hangers = 125mm
 Verhouding Gordijnlengte : Railengte = 1.78 : 1

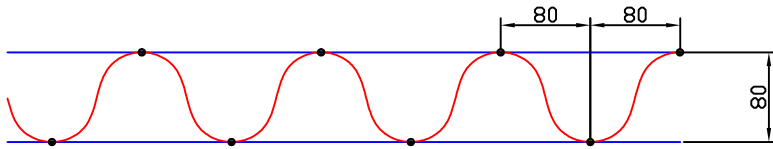

C-C Rail = 80mm
 Hanger elke 80mm
 Gordijnlengte tussen hangers = 130mm
 Verhouding Gordijnlengte : Railengte = 1.63 : 1

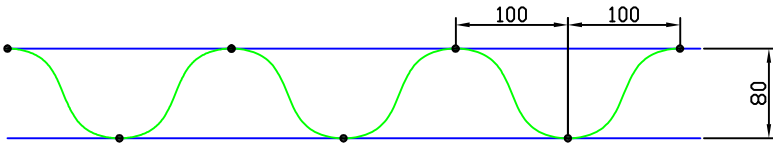

C-C Rail = 80mm
 Hanger elke 100mm
 Gordijnlengte tussen hangers = 145mm
 Verhouding Gordijnlengte : Railengte = 1.45 : 1

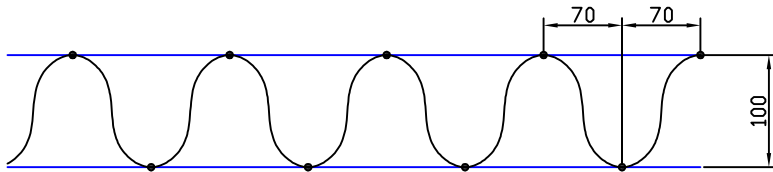

C-C Rail = 100mm
 Hanger elke 70mm
 Gordijnlengte tussen hangers = 135mm
 Verhouding Gordijnlengte : Railengte = 1,93:1

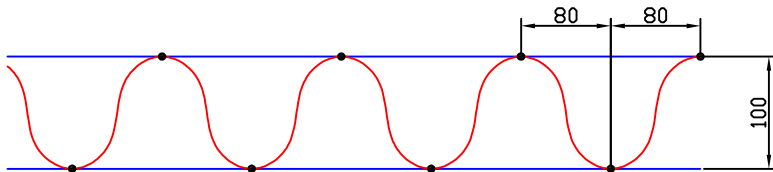

C-C Rail = 100mm
 Hanger elke 80mm
 Gordijnlengte tussen hangers = 145mm
 Verhouding Gordijnlengte : Railengte = 1,81:1

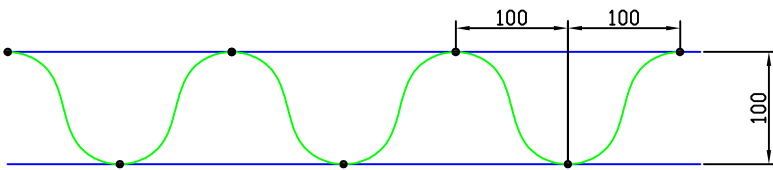

C-C Rail = 100mm
 Hanger elke 100mm
 Gordijnlengte tussen hangers = 160mm
 Verhouding Gordijnlengte : Railengte = 1.6 : 1

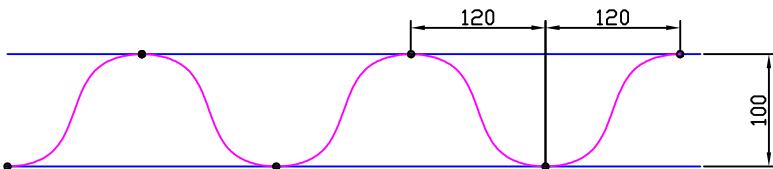

C-C Rail = 100mm
 Hanger elke 120mm
 Gordijnlengte tussen hangers = 175mm
 Verhouding Gordijnlengte : Railengte = 1.46 : 1